

WestRock

DuoStack[®] 1250

The fastest and most flexible stack machine in the world

WestRock DuoStack[®] 1250 requires no compromise, enabling the widest range of flat and stack pack configurations at the highest speed for a range of can dimensions.

- Offers packaging configurations as small as a 4 pack at the highest speed of any stack machine
- Includes innovation Trioval™ rotary robot module for:
 - Product metering and grouping
 - Accurate and rapid multi-height changeover
- Improves line efficiency with optional integrated tertiary packaging module
- Increases tolerance to cartons affected by environmental conditions with industry proven 3 wheel carton feeder

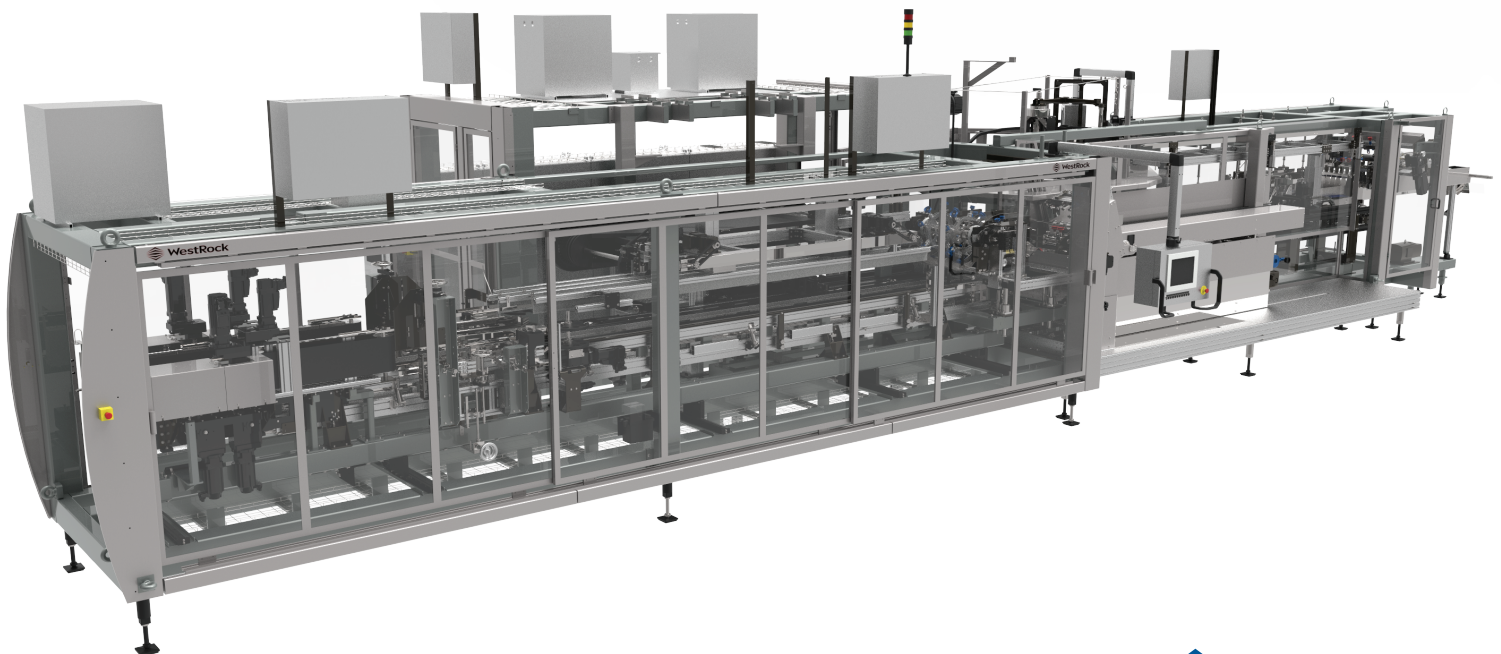

DuoStack® 1250

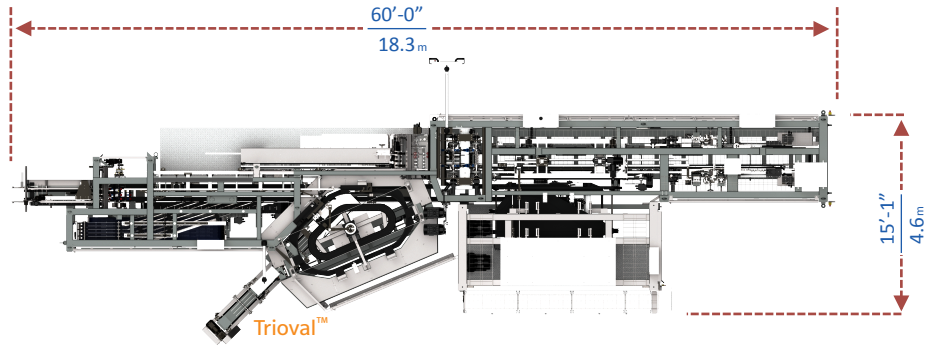
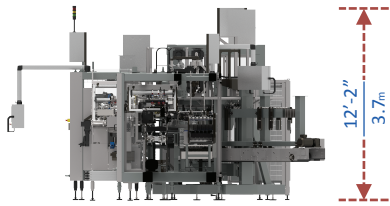

Features

- Two omni-directional touchscreen operator panels
- Auto lubrication system
- Multiple diameter and height capability
- Innovative Trioval™ rotary robot module
- Removable hopper
- Industry proven 3 wheel carton feeder

Primary Container

- Aluminum cans
- Height (flat packs) between 80mm & 157mm
- Height (stack packs) between 123mm & 157mm
- Diameter between 53mm & 66mm

Package Formats

- Flat packs: 4 through 24 pack
- Stack packs: 6/6 through 24/24 pack

Package Styles

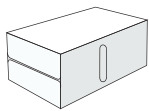

Gapped Flap DuoDozen®

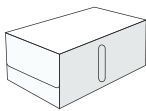

Mid-Overlapped DuoDozen®

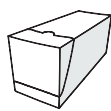

Fridgemaster®

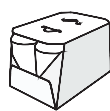

DuoWing®



Econodozen™

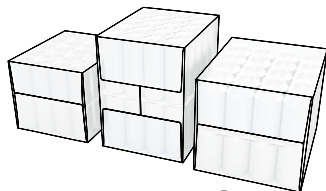

DuoStack®

Maximum Speeds

- Flat Packs:
 - 2x: up to 300 packs/minute
 - 3x: up to 150 packs/minute
 - 4x: up to 110 packs/minute
- Stack Packs: up to 100 packs/minute

Air & Power Requirements

- Air: 17 Nm³/hr at 6 bars
- Power: Customized to specific customer requirements

Changeover

- 20 to 120 minutes with one operator

Options

- Integrated tertiary packaging module
- Changeover parts trolley
- Sliding safety doors (light curtain standard)
- Extended, large capacity hopper

Note: All illustrations and specifications are subject to change without notice, and drawing dimensions are approximate and not to scale.

For more information contact
pkgequipment@westrock.com

Revision: January 2019

©2017 WestRock Company. All rights reserved.

westrock.com/beverage

