

WestRock

# Cluster-Pak<sup>®</sup> Ultima HF

Combination of high speed and flexibility

WestRock Cluster-Pak<sup>®</sup> Ultima HF sets the industry standard for speed and flexibility for dedicated can wrap machines.

- Offers flexibility to produce a full range of Cluster-Pak<sup>®</sup> wrap styles and features, including bar-code masking, StrongPak<sup>™</sup> retention gussets, or ad panels
- Enables easy operation and fast changeover with servo drive system and automatic subassembly repositioning
- Improves line efficiency with optional integrated tertiary packaging module

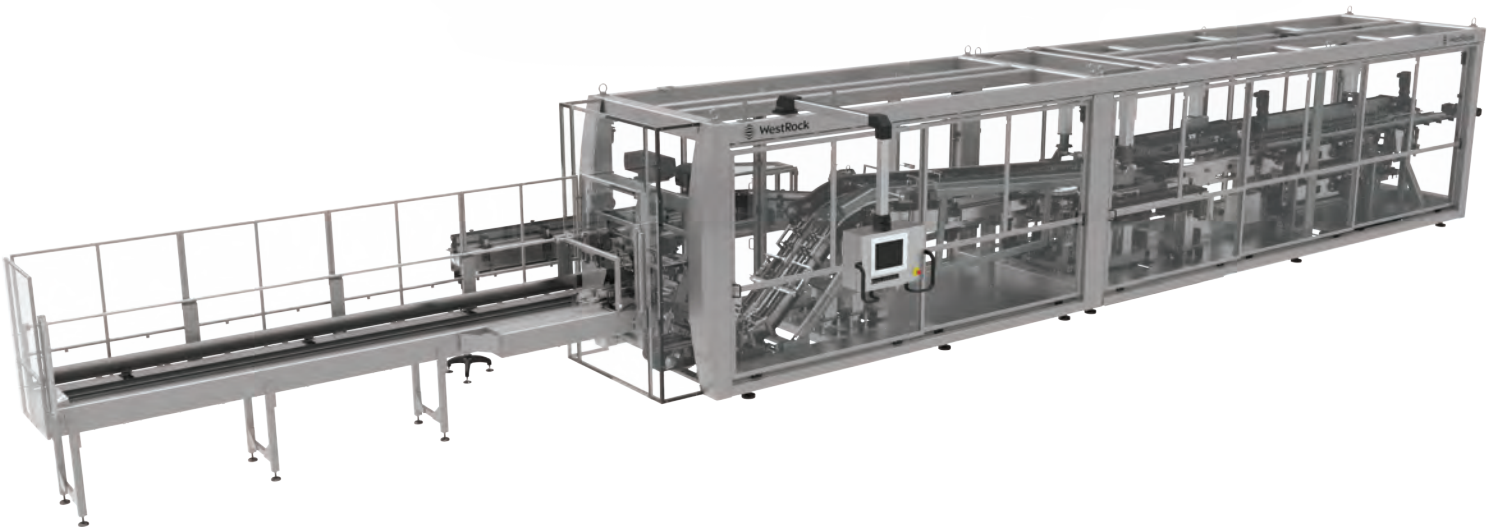

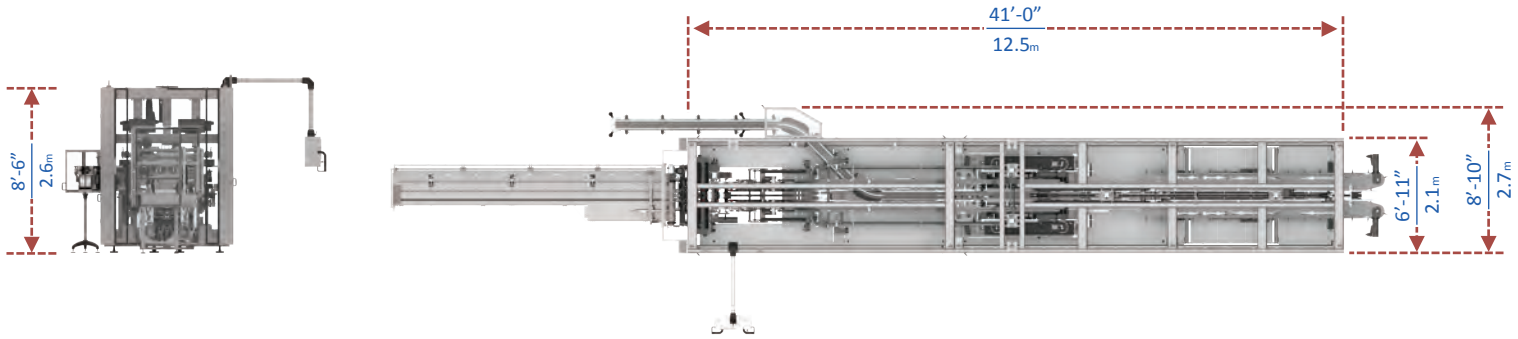

## Features

- Omni-directional touchscreen operator panel
- Servo control system
- Large capacity hopper (18 minutes at maximum speed)
- Automatic motor-driven changeovers
- Machine mounted electrical cabinet
- Integrated divider

## Primary Container

- Aluminum cans
- Diameter between 53mm & 66mm
- Height between 85mm & 200mm



## Package Formats

- Standard: 2x2, 2x3
- Optional: 2x4 through 2x6

## Package Styles

Full range of Cluster-Pak® features

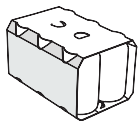

Standard wrap

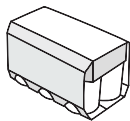

Full tuck ad panel

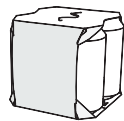

StrongPak™

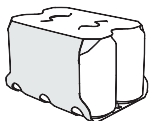

Chime Lock™

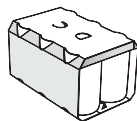

Standard ad panel

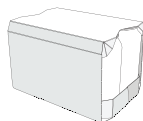

Barcode masking

## Maximum Speed

- 450 packs/minute

## Air & Power Requirements

- Air: 5 Nm<sup>3</sup>/hr at 6 bars
- Power: Customized to specific customer requirements

## Changeover

- Simple, automated and highly repeatable changeovers that optimize your filler throughput

## Options

- Integrated tertiary packaging module
- Integrated rotator/divider module
- Auto lubrication system

Note: All illustrations and specifications are subject to change without notice, and drawing dimensions are approximate and not to scale.